

EXOSTAND

ALL-IN-ONE WALL MOUNT



NOVELTIES
2021



COMPATIBLE
PLASTERBOARD
WALLS

1ST MOUNT REALLY COMPATIBLE
WITH PLASTERBOARD WALLS

ERARD®

All-in-one WALL MOUNT





EXOSTAND A new concept for plasterboard walls

Thanks to the "T" shape and the high and rigid structure of the column, part of the load is returned to the ground: your wall is 6x less stressed.



$$F_h = M \times G \times d / H$$

- F_h** = horizontal tensile force (Nm)
- M** = mass at the center of gravity (Kg)
- G** = gravitational constant (9.81)
- d** = distance from the center of gravity (m)
- H** = height between top and bottom points (m)

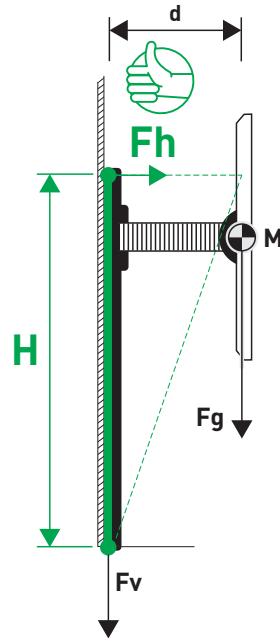

* Our pull tests conducted with a charge of 123 kg on common plasterboard type "BA13" (thickness 12.5 mm) guarantee a perfect fixing on your wall, without the need to attach to the studs.



COMPATIBLE WITH PLASTERBOARD

1ST MOUNT REALLY COMPATIBLE WITH PLASTERBOARD*

All-in-one WALL MOUNT

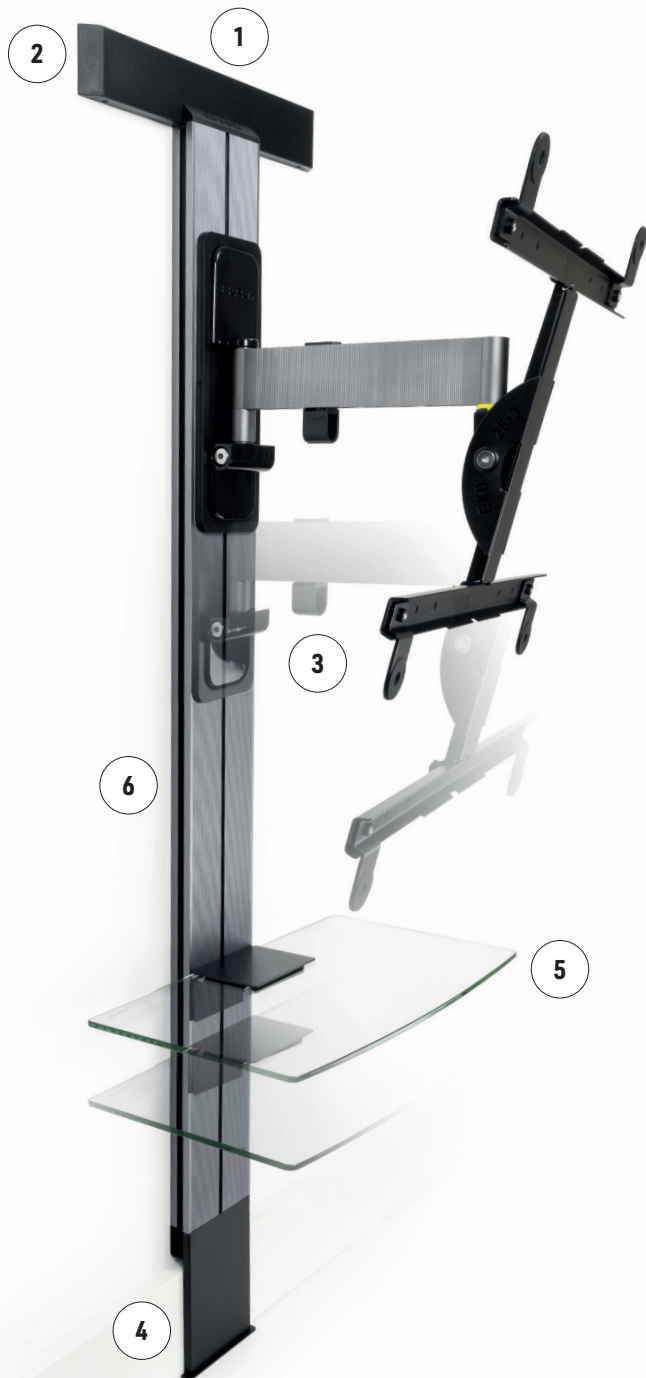

Discover the EXOSTAND video



www.erard.com/exostand



1 3 installation points



2 Patented drilling adjuster



3 Wall mount remains height adjustable after installation



4 Space left for baseboard

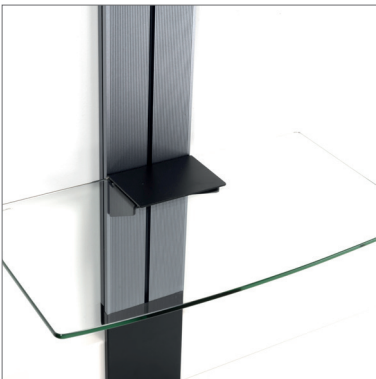

5 Removable and height adjustable shelf



6 Cable management integrated in the column

All-in-one WALL MOUNT

EXOSTAND

ALL-IN-ONE WALL MOUNT FOR 30-85" SCREENS

- A set composed of a tilting and swivelling wall mount, a floor-wall column and a shelf for a peripheral.
- Texturized anodized aluminium arm and column, Titanium colour.
- Screen and wall mount made of steel, black epoxy painting.
- Compatible with all types of walls, including plasterboard walls (expansion screws and installation tool provided).
- Magnetic cover for wall mount.
- Includes screws and spacers required for an installation of a screen with curved or irregular back panel (KitAdapt+).
- Compatible with all types of screens (LCD, LED, QLED, OLED).



EXOSTAND400

Ref **048440** EAN 318528 048440 9

COLUMN + TILTING AND SWIVELLING MOUNT WITH OFFSET FOR 30"-65" SCREENS

L 30"-65"
76 - 165 cm

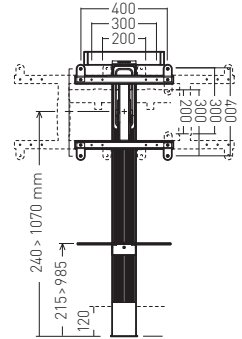
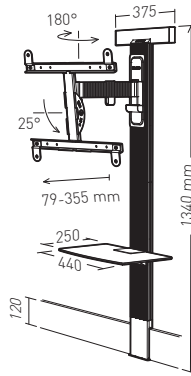
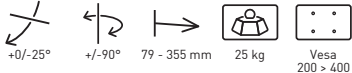

EXOSTAND600

Ref **048460** EAN 318528 048460 7

COLUMN + TILTING AND SWIVELLING MOUNT WITH OFFSET FOR 40"-85" SCREENS

XL 40"-85"
101 - 215 cm

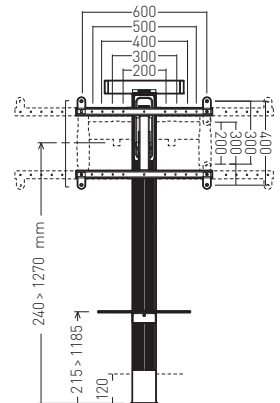
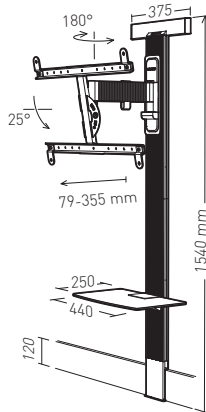
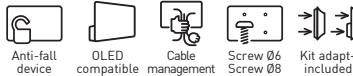
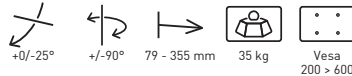

EXOSTANDPRO

Ref **048461** EAN 318528 048461 4

COLUMN + TILTING AND SWIVELLING MOUNT WITH OFFSET FOR 40"-85" SCREENS

XL 40"-85"
101 - 215 cm

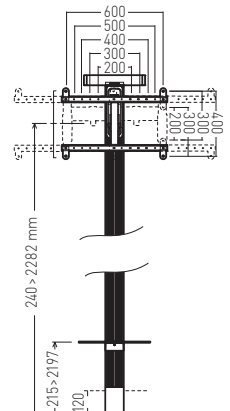
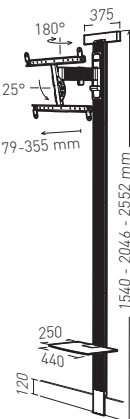
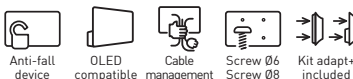



New
EXOSTAND
see pages 48 - 53



Find out all the novelties
in our Mounts and furniture
2021 catalogue

New

EXOXXLTW3

see page 47



New

Exo blanc

see page 45



New

Lux-Up T

see page 79



New

FITUP XXL

see page 93



New

NAGA 2000

see page 76

